

基礎詳細図 S=1/20

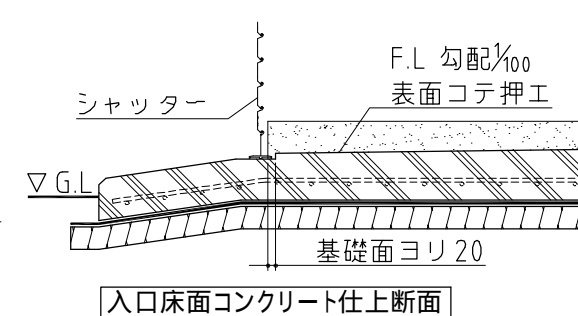
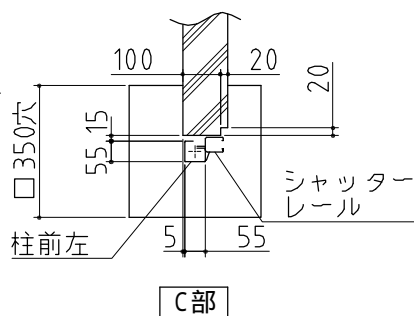
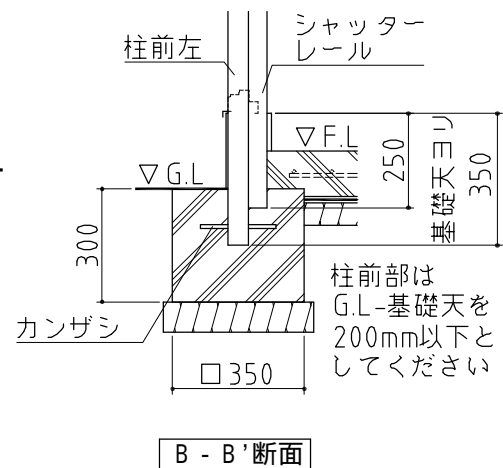
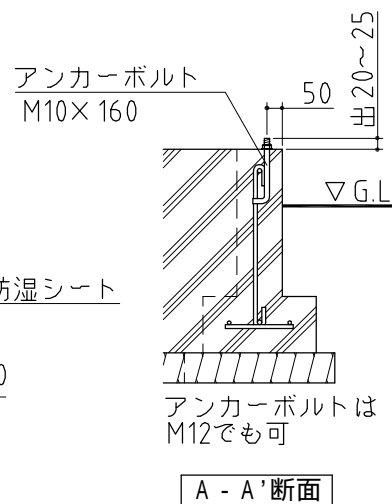
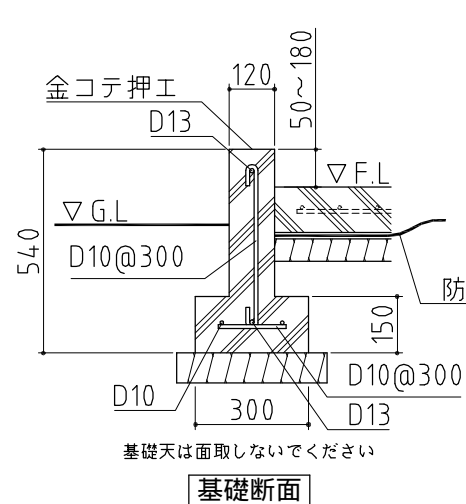

基礎図

NO.28 <縮尺> S=1/50
~一般型・多雪地型~

機種名 FXN-95HD

寒冷地等は、地域の実情に合わせた基礎にしてください。