

平面図

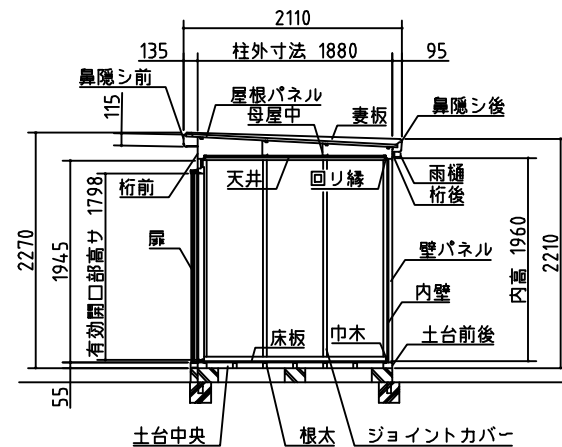

断面図

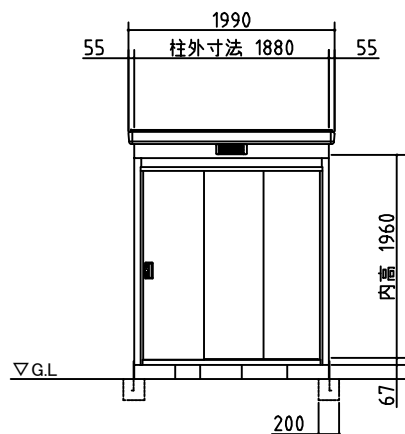

正面図

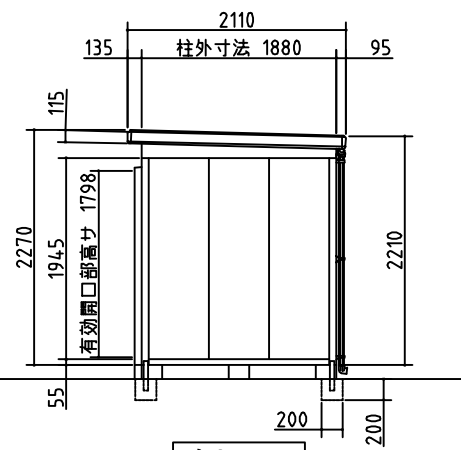

側面図

外形図	NO.02 <縮尺> S=1/50 ~一般型・多雪地型~
	機種名 SMK-36S
○扉部有効開口寸法: 1090 × 1798 (mm) ○床面積: 3.53㎡(1.07坪)	