

断面図

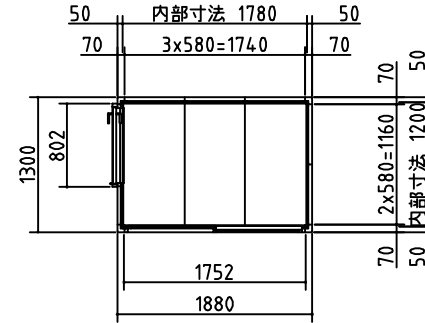

平面図

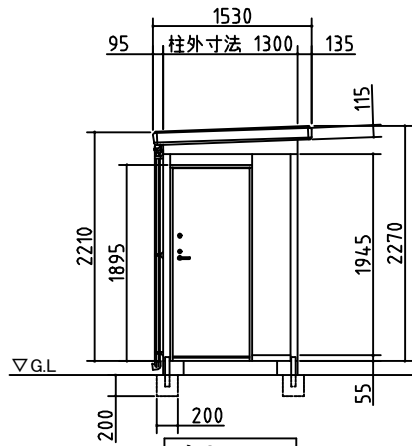

側面図

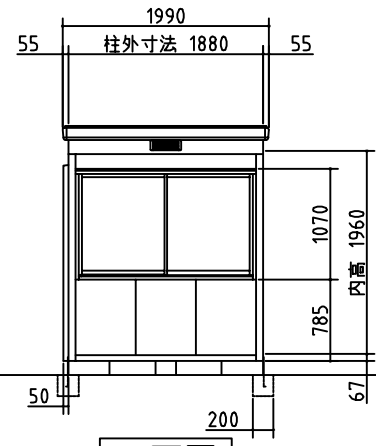

正面図

外形図	NO.18 <縮尺> S=1/50 ~一般型・多雪地型~
	機種名 SMK-25SGM
○ドア部有効開口寸法: 677×1760 (mm)	
○床面積: 2.44㎡(0.74坪)	