

基礎詳細図 S=1/20

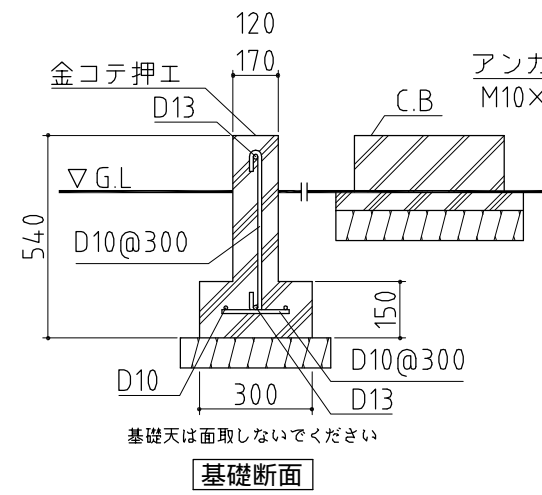

基礎断面

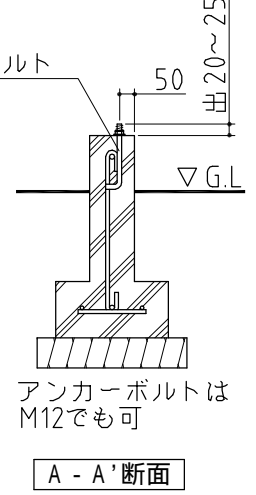

A - A' 断面

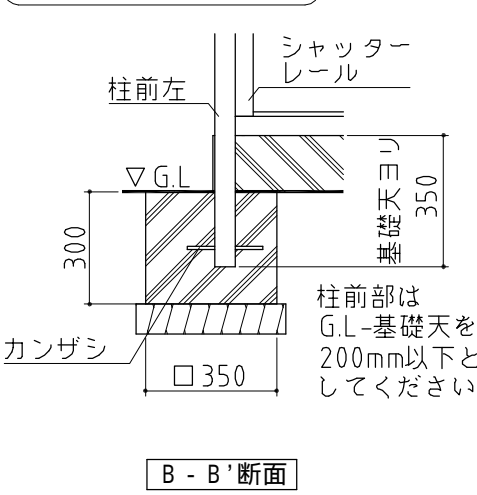

B - B' 断面

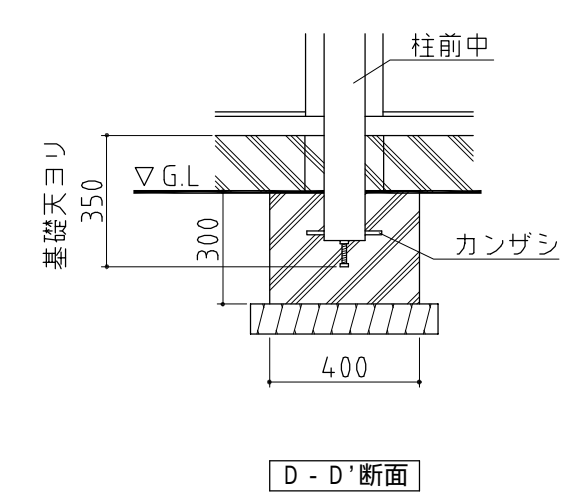

D - D' 断面

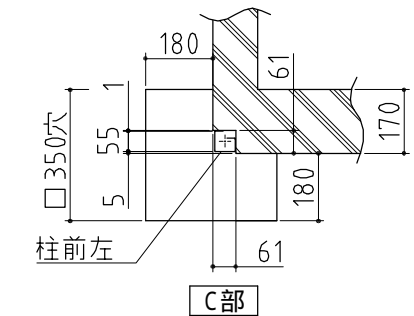

C部

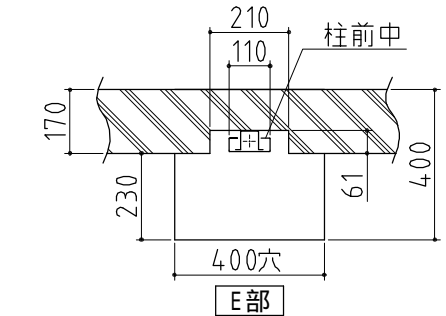

E部

基礎図	NO.07 <縮尺> S=1/50 ~一般型・多雪地型~
	機種名 FXN-60HYL-2
寒冷地等は、地域の実情に合わせた基礎にしてください。 布基礎には換気口を設けてください。	