

基礎詳細図 S=1/20

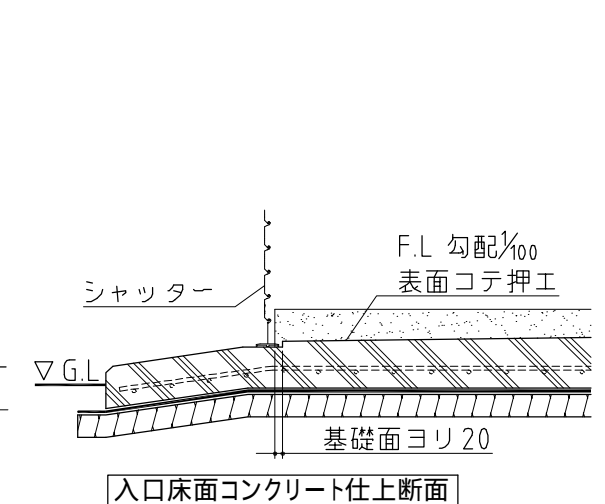
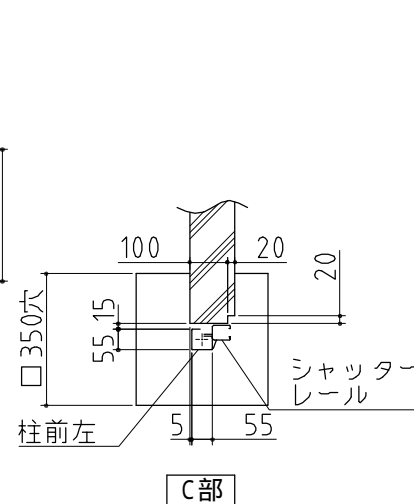
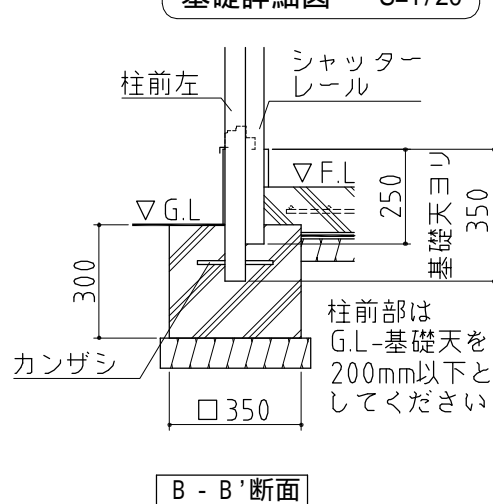
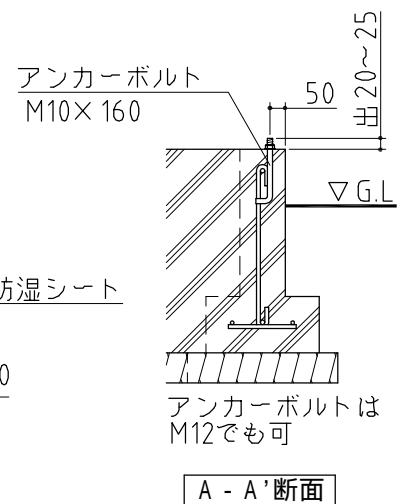
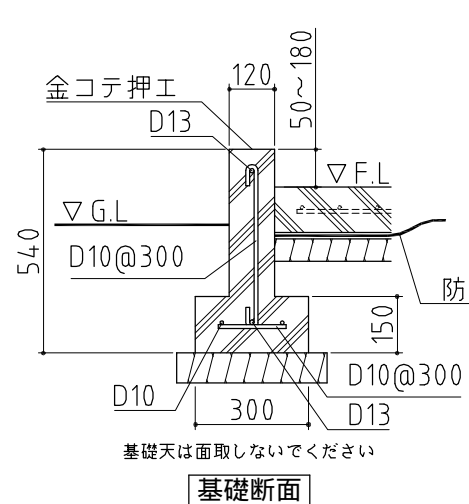

基礎図 NO.03 <縮尺> S=1/50
 ~一般型・多雪地型~
機種名 FXN-50HD
 寒冷地等は、地域の実情に合わせた基礎にしてください。